

Turmdrehkran

Tower Crane / Grue à tour / Gru a torre
Grúa torre / Guindaste de torre

130 EC-B 6 FR.tronic®

130 EC-B 6

▶ **130 EC-B 6 FR.tronic®**

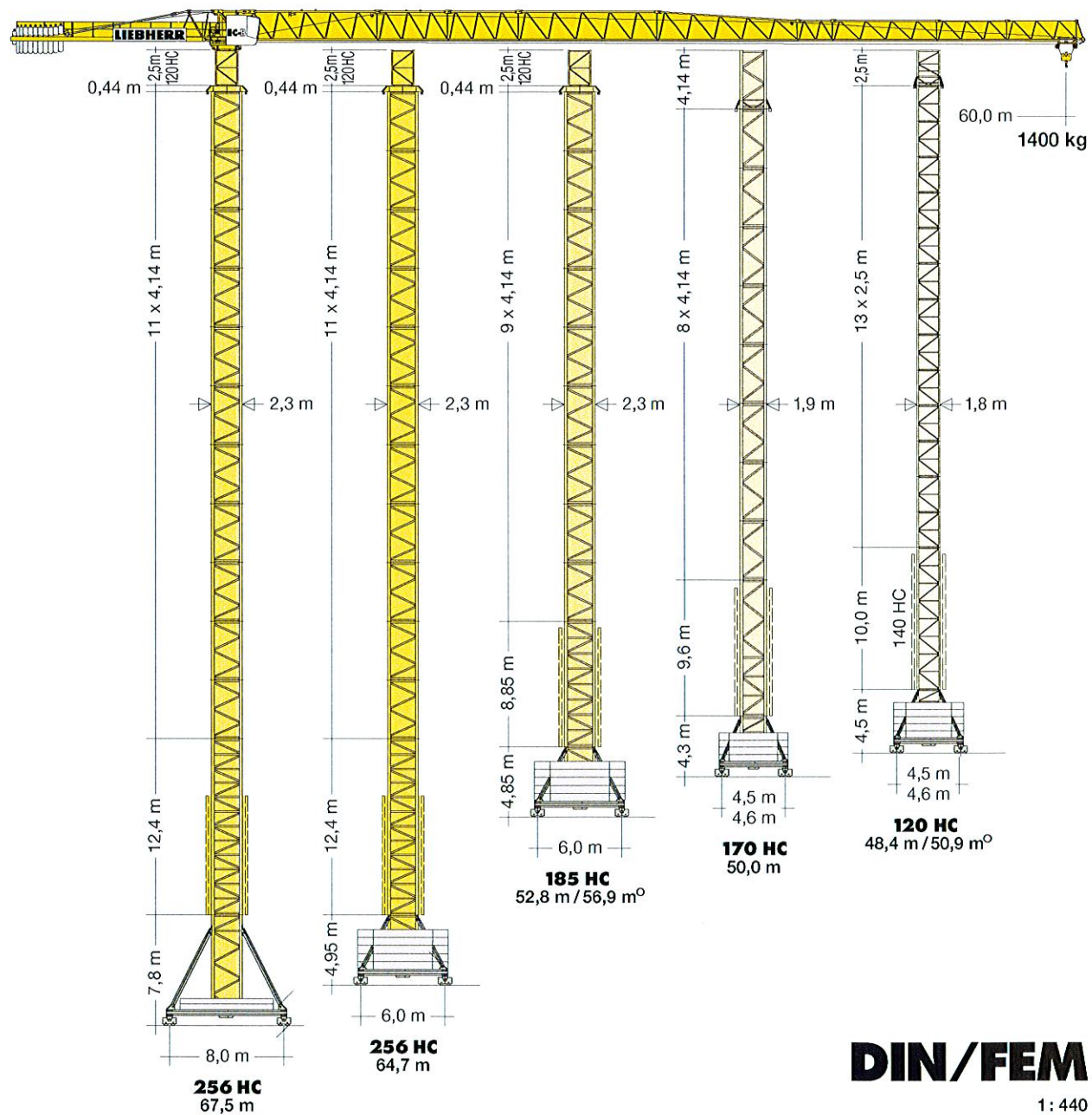

LIEBHERR

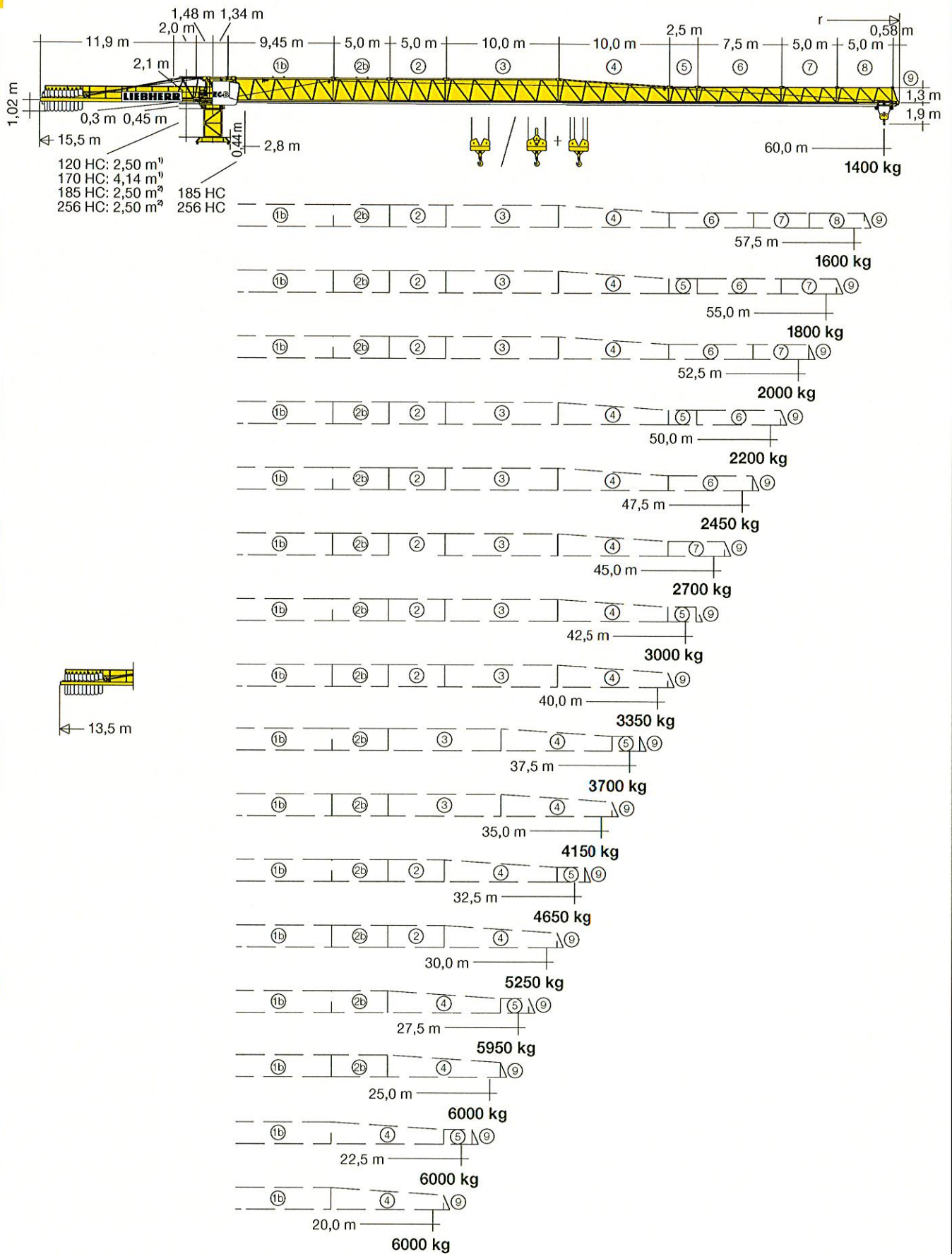

¹⁾ Turmstück oder Kletterturmstück. / Tower section or climbing tower section. / Élément de mât ou élément de mât télescopable. / Elemento torre oppure elemento torre telescopabile. / Tramo torre o tramo torre trepable. / Segmento de torre ou segmento de torre para ascensão.

²⁾ Turmstück 120 HC. / Tower section 120 HC. / Élément de mât 120 HC. / Elemento di torre 120 HC. / Tramo torre 120 HC. / Segmento de torre 120 HC.

Ausladung und Tragfähigkeit

Radius and capacity / Portée et charge / Sbraccio e portata / Alcances y cargas / Alcance e capacidade de carga

130 EC-B 6 FR.tronic®

m	r	m/kg	m/kg																
			20,0	22,5	25,0	27,5	30,0	32,5	35,0	37,5	40,0	42,5	45,0	47,5	50,0	52,5	55,0	57,5	60,0
60,0	(r = 61,5)	$\frac{2,8-18,6}{6000}$	5550	4850	4300	3850	3470	3150	2880	2640	2430	2250	2090	1940	1810	1700	1590	1490	1400
57,5	(r = 59,0)	$\frac{2,8-19,6}{6000}$	5870	5140	4550	4080	3680	3350	3060	2810	2590	2400	2230	2080	1940	1820	1700	1600	
55,0	(r = 56,5)	$\frac{2,8-20,4}{6000}$	6000	5370	4770	4270	3860	3510	3210	2950	2730	2530	2350	2190	2050	1920	1800		
52,5	(r = 54,0)	$\frac{2,8-21,0}{6000}$	6000	5570	4940	4430	4000	3640	3340	3070	2830	2630	2450	2280	2130	2000			
50,0	(r = 51,5)	$\frac{2,8-21,5}{6000}$	6000	5720	5080	4550	4120	3750	3430	3160	2920	2710	2520	2350	2200				
47,5	(r = 49,0)	$\frac{2,8-22,2}{6000}$	6000	5930	5260	4720	4270	3890	3570	3280	3040	2820	2620	2450					
45,0	(r = 46,5)	$\frac{2,8-22,8}{6000}$	6000	6000	5400	4850	4390	4000	3660	3370	3120	2900	2700						
42,5	(r = 44,0)	$\frac{2,8-23,4}{6000}$	6000	6000	5580	5010	4530	4130	3790	3490	3230	3000							
40,0	(r = 41,5)	$\frac{2,8-24,1}{6000}$	6000	6000	5760	5180	4690	4280	3920	3620	3350								
37,5	(r = 39,0)	$\frac{2,8-24,6}{6000}$	6000	6000	5890	5290	4790	4370	4010	3700									
35,0	(r = 36,5)	$\frac{2,8-25,3}{6000}$	6000	6000	6000	5470	4950	4520	4150										
32,5	(r = 34,0)	$\frac{2,8-25,9}{6000}$	6000	6000	6000	5620	5090	4650											
30,0	(r = 31,5)	$\frac{2,8-26,6}{6000}$	6000	6000	6000	5790	5250												
27,5	(r = 29,0)	$\frac{2,8-27,3}{6000}$	6000	6000	6000	5950													
25,0	(r = 26,5)	$\frac{2,8-25,0}{6000}$	6000	6000	6000														
22,5	(r = 24,0)	$\frac{2,8-22,5}{6000}$	6000	6000															
20,0	(r = 21,5)	$\frac{2,8-20,0}{6000}$	6000																

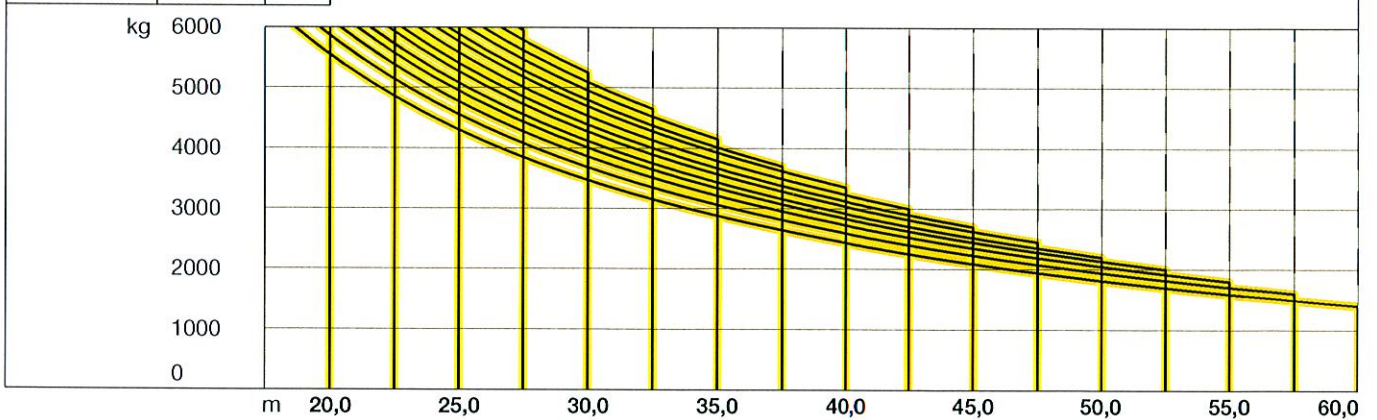

120 HC														
14	47,7* ^o	50,9* ^o	47,2* ^o	50,4* ^o	44,8* ^o	48,0* ^o	43,4* ^o	46,6* ^o	-	-	-	-	-	
13	45,2*	48,4*	44,7*	47,9*	42,3*	45,5*	40,9*	44,1*	-	-	42,4*	-	42,2*	
12	42,7	45,9	42,2	45,4	39,8	43,0	38,4	41,6	39,9*	-	39,9	43,1*	39,7	
11	40,2	43,4	39,7	42,9	37,3	40,5	35,9	39,1	37,4	40,6*	37,4	40,6	37,2	
10	37,7	40,9	37,2	40,4	34,8	38,0	33,4	36,6	34,9	38,1	34,9	38,1	34,7	
9	35,2	38,4	34,7	37,9	32,3	35,5	30,9	34,1	32,4	35,6	32,4	35,6	32,2	
8	32,7	35,9	32,2	35,4	29,8	33,0	28,4	31,6	29,9	33,1	29,9	33,1	29,7	
7	30,2	33,4	29,7	32,9	27,3	30,5	25,9	29,1	27,4	30,6	27,4	30,6	27,2	
6	27,7	30,9	27,2	30,4	24,8	28,0	23,4	26,6	24,9	28,1	24,9	28,1	24,7	
5	25,2	28,4	24,7	27,9	22,3	25,5	20,9	24,1	22,4	25,6	22,4	25,6	22,2	
4	22,7	25,9	22,2	25,4	19,8	23,0	18,4	21,6	19,9	23,1	19,9	23,1	19,7	
3	20,2	23,4	19,7	22,9	17,3	20,5	15,9	19,1	17,4	20,6	17,4	20,6	17,2	
2	17,7	20,9	17,2	20,4	14,8	18,0	13,4	16,6	14,9	18,1	14,9	18,1	14,7	
1	15,2	18,4	14,7	17,9	12,3	15,5	10,9	14,1	12,4	15,6	12,4	15,6	12,2	
0	12,7	15,9	12,2	15,4	9,8	13,0	8,4	11,6	9,9	13,1	9,9	13,1	9,7	
	m a)	b)	m a)	b)	m a)	b)	m a)	b)	m a)	b)	m a)	b)	m a)	b)

	170 HC	185 HC	256 HC
12	-	-	64,1*
11	-	-	60,0
10	-	-	55,9
9	50,1*	52,3* ^o	64,7*
8	46,0*	48,2*	60,5
7	41,8	45,9*	56,4
6	37,7	41,7	52,3
5	33,6	37,6	48,1
4	29,4	33,5	44,0
3	25,3	29,3	39,8
2	21,1	25,2	35,2
1	17,0	21,0	31,0
0	12,9	16,9	26,9
	m	m	m





^o = Ohne Kabine. / Without cabin. / Sans cabine. / Senza cabina. / Sin cabina. / Sem cabine.

Weitere Hubhöhen sowie Klettern im Gebäude auf Anfrage. / Further hoist heights and climbing in the building on request.
 Hauteurs sous crochet plus élevées et hissage dans le bâtiment sur demande. / Altre altezze di sollevamento come pure varianti di gru allungabili: su richiesta. / Para alturas bajo gancho superiores y trepado en el interior del edificio, consultar. / Outras alturas de elevação e subida no edifício: conforme ao pedido.

Antriebe

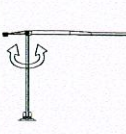
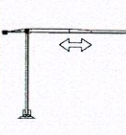
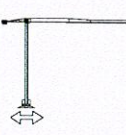
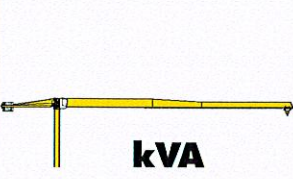
Driving units / Mécanismes d'entraînement / Azionamenti / Mecanismos / Mecanismos

	U/min 0 ↔ 0,8 sl./min tr./min	7,5 kW FR.tronic-FU
	0 ↔ 80,0 m/min	5,4 kW FR.tronic-FU
	25,0 m/min	2 x 4,0 kW
	kVA	30 kW FU 33,0



↔ **stufenlos** / stepless / régl. continu
regl. progressiva / sin escalones / sem degraus
kg m/min

30 kW FR.tronic-FU
WIW 240 MZ 403

5 **Lagen**
Layers
Couches
Strati
Camadas
Capas

100,0 m

174,0 m**

1	6000	0 ↔ 26
	550	0 ↔ 126

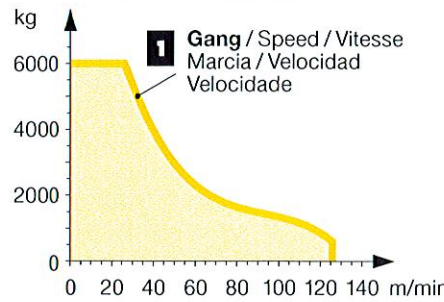





















Gang / Speed / Vitesse
Marcia / Velocidad
Velocidade

** Weitere Hubhöhen: siehe Betriebsanleitung. / Further hoist heights: see instruction manual. / Autres hauteurs sous crochet: voir manuel d'instruction / Altre altezze di sollevamento: vedasi le istruzioni sull'uso. / Alturas bajo grancho superiores según manual. / Outras alturas de elevação: consultar manual de instruções.

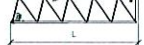
Kolli-Liste

Packing List / Liste de colisage / Lista dei colli / Lista de contenido / Lista de embalagem

Montagegewichte: siehe Betriebsanleitung. / Erection weights: see instruction manual. / Poids de montage: voir manuel de service. / Pesos de montaggio: vedasi le istruzioni sull'uso. / Pesos de montagem: vejã-se as instruções p. uso. / Peso para el montaje: según manual.

Kranoberteil		Upper part of crane / Partie supérieure de grue / Parte superiore della gru Parte superior grúa / Parte superior do guindaste	L (m)	B (m)	H (m)	kg*		
Pos. Item Ref.	Anz. Qty. Cant.	Drehbühne mit Podesten / Slewing platform with platforms Plate-forme tournante avec plates-formes / Piattaforma girevole con pedana / Plataforma giratoria con plataforma Plataforma giratória com plataforma			3,03	3,35	2,83 (2,51)	7720
2	1	Drehbühne / Slewing platform Ensemble mât cabine / Piattaforma girevole / Conjunto plataforma de giro Plataforma giratória compl.			3,03	2,43	2,83 (2,51)	7290
3	1	Podeste / Platforms Plates-formes / Pedana Plataformas / Plataformas			2,80 3,09 2,80	1,10 0,79 1,12	1,24 1,29 1,22	250 200 170
4	1	Kabine / Cabin Cabine / Cabina Cabina / Cabina			3,57	1,38	2,27	690
5	1	Gegenausleger-Anlenkstück / Counter-jib heel section Pied de contre-flèche / Settore articolato di controbraccio Tramo primero-contrapluma / Base articulada da contra-lança			2,75	1,20	2,25	760
6	1	Gegenausleger / Counter-jib Contre-flèche / Contrabaccio Contrapluma / Contra-lança			11,98	1,40	0,81	2700
7	1	Podeste Gegenausleger / Counter-jib platforms Plates-formes de contre-flèche / Ballatoi contrefreccia Plataforma contrapluma / Plataforma contra-lança			4,00	0,69	1,35	180
8	1	Ausleger-Anlenkstück / Jib heel section Pied de flèche / Settore articolato di braccio Pluma tramo primero / Base articulada de lança			9,67	1,34	2,25	Ⓜ 2230
9	1	Ausleger-Zwischenstück / Intermediate jib section Élément intermédiaire de flèche / Spezzone di braccio Tramo intermedio pluma / Peça suplementar da lança			5,26 5,27 10,26 2,72 7,71 5,19 5,17	1,20 1,20 1,20 1,20 1,20 1,20 1,20	2,15 2,15 2,14 1,48 1,48 1,46 1,45	Ⓜ 840 Ⓜ 750 Ⓜ 1230 Ⓜ 200 Ⓜ 500 Ⓜ 230 Ⓜ 200
10	1	Ausleger-Zwischenstück / Intermediate jib section Élément intermédiaire de flèche / Spezzone di braccio Tramo intermedio pluma / Peça suplementar da lança			10,22	1,20	2,08	Ⓜ 860

Pos. Item Voce Pos. Ref.	Anz. Qty. Qta. Cant.				L (m)	B (m)	H (m)	kg*	
11	1	Ausleger-Kopfstück / Jib head section Pointe de flèche / Punta freccia Tramo punta de pluma / Cabeça de lança			1,40	1,21	0,46	94	
12	1	Laufkatze / Trolley Chariot / Carrello Carrito / Carrinho			1,62	1,38	1,29	530	
13	1	Fahrkorb / Maintenance cage Nacelle d'entretien / Cestello di manutenzione Plataforma de mantenimiento / Cesto do carrinho			0,78	0,66	1,25	35	
Turm Tower / Mât / Torre Torre / Torre									
14	15	Turmstück / Tower section Élément de mât / Elemento di torre Tramo torre / Torre			120 HC	2,50	1,80	1,80	1090
10	170 HC				4,14	1,90	1,90	1850	
10	185 HC				4,14	2,30	2,30	2240	
12	256 HC				4,14	2,30	2,30	2300	
15	7	Turmstück lang / Long tower section Élément de mât long / Elemento di torre, lungo Tramo de torre largo / Peça de torre, comprida			120 HC	5,00	1,80	1,80	1830
3	120 HC				10,00	1,80	1,80	3430	
	120 HC				12,50	1,80	1,80	4200	
16	1	Grundturmstück / Base tower section Mât de base / Elemento di torre base Tramo base / Peça de base de torre			140 HC	6,85	1,80	1,80	2930
	140 HC				10,00	1,80	1,80	3990	
	170 HC				9,60	1,90	1,90	4480	
	185 HC				8,85	2,30	2,30	4280	
	256 HC				8,85 (12,42)	2,30 (2,30)	2,30 (2,30)	4830 (7940)	
17	1	Kletterturmstück / Climbing tower section Élément de hissage de mât / Elemento torre di telescopaggio / Tramo de trepado Tramo de telescopagem			120 HC	2,75	2,20	2,45	1450
	170 HC				4,30	2,30	2,45	2280	
Klettereinrichtung Climbing equipment / Equipement de télescopage / Attrezzatura per allungamento della gru Equipo de trepado / Acesoários p. subida no edificio									
18	1	Führungsstück kpl. / Guide section cpl. / Cage télescopique cpl. / Gabbia de sopraelevazione compl. Torre de montaje completa / Peça de guia compl.			120 HC	6,45	2,10	2,42	3500
	120 HC				9,60	2,10	2,42	4440	
	170 HC				9,04	2,31	2,28	4380	
	185 HC				8,39	2,68	2,58 (3,04)	5200	
	256 HC				8,39	2,68	2,58 (3,04)	5200	
19	1	Hydraulikanlage, Stütz- u. Klettertraverse / Hydraulic unit, supporting a. climbing cross members / Système hydraulique avec traverses d'appui et de télescopage Sistema idraulico, traversa di appoggio e allungamento gru / Sistema hidráulico con traviesa de apoyo y trepado / Instalação hidráulica, travessa de apoio e subida			120 HC	2,87	2,12	1,06	1050
	170 HC				2,00	1,10	1,00	1100	
	185 HC				2,30	1,25	1,00	1150	
	256 HC				2,30	1,25	1,00	1150	
Unterwagen Undercarriage / Châssis / Carro della gru Carro con mástil / Carro de guindaste									
20	2	Fahrschemel mit Antrieb / Rail bogie with drive Bogie moteur / Telaio con gruppo propulsore Caja rodillo motriz / Quadro sem grupo de propulsão			120 HC	1,38	0,88	0,87	900
	170 HC				1,46	0,84	0,87	920	
	185 HC				1,46	0,84	0,87	920	
	256 HC				1,63 (1,46)	0,92 (0,84)	0,95 (0,87)	1690 (920)	
21	2	Fahrschemel ohne Antrieb / Rail bogie without drive Bogie fou / Telaio senza gruppo propulsore / Caja rodillo conducido / Quadro com grupo de propulsão			120 HC	1,17	0,60	0,87	860
	170 HC				1,15	0,60	0,87	880	
	185 HC				1,15	0,60	0,87	880	
	256 HC				1,37 (1,15)	0,62 (0,60)	0,95 (0,87)	1340 (880)	
22	1	Tragholm lang / Long support arm Longeron long / Longherone lungo Brazo soporte largo / Travessa comprida			120 HC	7,12	0,78	0,65	950
	170 HC				7,15	0,80	0,70	1070	
	185 HC				9,10	0,82	0,74	1350	
	256 HC				9,10 (11,95)	0,80 (0,82)	0,80 (0,80)	1650 (2200)	
23	2	Tragholm kurz / Short support arm Longeron court / Longherone corto Brazo soporte corto / Travessa curta			120 HC	3,45	0,56	0,55	408
	170 HC				3,45	0,60	0,70	500	
	185 HC				4,41	0,62	0,71	615	
	256 HC				4,45 (5,58)	0,77 (0,65)	0,77 (0,77)	800 (1035)	
24	2 + 2	Randträger / Border support Traverse / Supporti base Traviesa / Apoio de bordo			120 HC	4,02	0,35	0,12	95
	170 HC				4,08 - 4,30	0,16 - 0,33	0,11 - 0,14	80 - 200	
	185 HC				5,48 - 5,46	0,11 - 0,17	0,16 - 0,38	118 - 454	
	256 HC				5,46 - 5,40 (7,52 - 7,46)	0,11 - 0,18 (0,10 - 0,17)	0,16 - 0,38 (0,10 - 0,38)	175 - 525 (366 - 912)	
25	4	Stützholm / Support strut Hauban de châssis / Correnti di appoggio Tirante vertical / Travessa de apoio			120 HC	3,78	0,15	0,22	200
	170 HC				3,53	0,25	0,17	240	
	185 HC				4,23	0,17	0,25	275	
	256 HC				4,14 (6,55)	0,18 (0,22)	0,25 (0,25)	320 (600)	
26	1	Unterwagen-Turmstück / Undercarriage tower section Mât de châssis / Elemento di torre del carro Tramo de carro / Peça de torre do chassis			120 HC	3,50	2,06	2,06	1320
	170 HC				3,30	2,15	2,15	2000	
	185 HC				3,73	2,52	2,52	1950	
	256 HC				3,73 (6,70)	2,62 (2,53)	2,62 (2,53)	2550 (3800)	
27	1	Stapel Aufstiege und Podeste / Bundle of ladders and platforms Faisceau d'échelles et de plates-formes / Serie di scale e rampe Paquete de escaleras y plataformas / Escadas e patamares			120 HC	3,50	1,20	1,00	1000
28	1	Kiste mit Kleinteilen / Crate with small parts Caisse contenant des accessoires / Cassa con accessori Caja con accesorios / Caixa de acessórios			2,00	1,00	1,00	2000	

() Angaben in Klammern gelten für 8 m-Unterwagen. / The data in brackets are valid for an undercarriage of 8 m. / Les données techniques indiquées entre parenthèses sont valables pour un châssis de 8 m. / Caratteristiche in (...) valgono per carro di 8 m. / Los datos entre paréntesis son válidos para carro de 8 m. / Características em (...) válidas pelo chassis de 8 m.

* Einzelgewichte. / Single weights. / Poids individuels. / Pesì di componenti. / Pesos unitarios. / Pesos de peças componentes.

Konstruktionsänderungen vorbehalten!

Subject to alterations! / Sous réserves de modifications!
Si fa riserva di modifiche! / ¡Sujeto a modificaciones!
Salvo modificação da construçao!

Sämtliche Angaben erfolgen ohne Gewähr. / This information is supplied without liability.

Ces renseignements sont sans garantie. / Le indicazioni contenute si intendono salvo errori ed omissioni.
Declinamos toda responsabilidad derivada de la informaciòn proporcionada. / Declinamos qualquer
responsabilidade quanto à informaçao fornecida.

121 P - 5257 H1 B3 DIN 15018 • BGL C.0.10.0125 / FEM (Section 1) - Krangruppe A3 • 11.06 / 6

Printed in Germany.